



LPT44

Lithium Pallet Truck

Patents pending



CAPACITY 4,400 Lbs.

EASY EXCHANGE LITHIUM ION BATTERY

48-volt 30AH rechargeable
110VAC 13.5A plug-in internal charger

DRIVE AND TRAVEL CONTROLS

48-volt Curtis travel control with permanent magnet drive motor.

Variable speed from 0 mph to 3.7 mph empty
Variable speed from 0 mph to 3.3 mph loaded

WEIGHT

550 lbs. with battery

TIRES

Drive (1) 9.6" x 3.7" polyurethane
Load (2) 3.25" x 4.5" polyurethane

FORKS 27" OAW x 46" OAL

Designed for use with standard 48" pallets and other common skids and containers. Forks can achieve a maximum elevation of over 8.5" and are built for heavy duty use and come standard with a robust fork entry roller for reliable pallet entry.

CONTROL HEAD

Travel, lift, and lower functions are located on the ergonomic control head. All operator controls are accessible without having to lift one's hand from the handle grips. The control head is designed to allow for easy operation of with either hand and includes a belly button reversing switch, dual butterfly travel controls, horn, and battery discharge indicator and key switch. The low mounted tiller arm offers excellent operator comfort and minimum steering effort.



HYDRAULICS

DC pump and chrome plated cylinder provide for smooth and efficient lifting.

ELECTRICAL

Water resistant connectors and shrouded wiring harness supply power reliably to components. System includes an emergency power disconnect and covered on-board dock for the Easy Exchange HD Battery.

BRAKES

Electromechanical brake provides good stopping power when handle is upright or lowered beyond the operating range.

SERVICEABILITY

Removable covers and modular design of components provides for easy maintenance with simple hand tools. Two piece drive wheel reduces complexity of tire changes.

DUTY CYCLE

Revolutionary Easy Exchange HD Battery delivers up to 3.5 hours of operation and can be fully charged within 2 hours. Optional extra batteries can be purchased to extend run time or to serve as a reliable back-up.



OPTIONAL

- 48" load back rest
- Traction tire
- Stability casters
- Extra Easy Exchange HD batteries and an optional external charger are available to support a virtually infinite duty cycle.

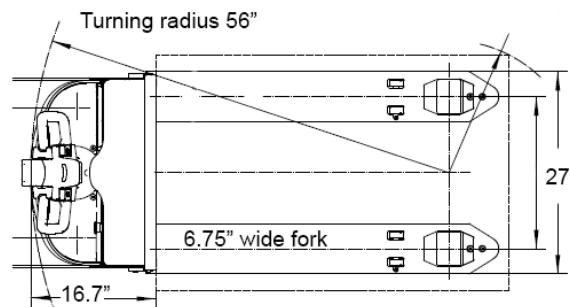
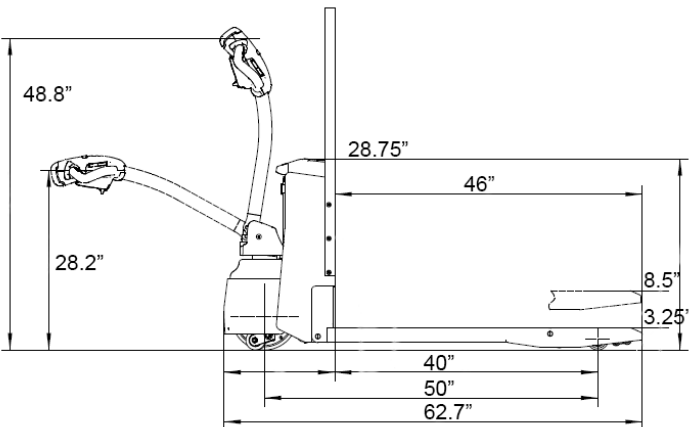

www.bigjoeforklifts.com
630-916-2600

Certification
All units are built to be in compliance with the Occupational Safety & Health Act (OSHA)

Big Lift LLC will not assume liability for injuries or damage arising from, or caused by, the removal of any safety devices from their vehicles by user. Because of Big Lift continuing to improve products, specifications are subject to change without notice.

© Copyright 2020, Big Lift LLC Printed USA 0320