



V15

Sit-Down Counterbalanced



CAPACITY

V-15 2800 lbs. at 24" load center

BATTERY

V-15 Battery compartment: 32" x 19" x 24"
Minimum battery weight 1520 lbs. No cover
Anderson 350 Blue-A22

PERFORMANCE

48 volt batteries with 400-600 Ah capacity
ZAPI AC lift and travel control.

TRAVEL

9.1 mph empty
8.12 mph loaded

LIFT

Up to 110 fpm empty
Up to 61 fpm loaded

LOWERING

Up to 85 fpm empty.
Up to 105 fpm loaded

TIRES

FRONT DRIVE X 2
18" x 7.8" solid pneumatic
DUAL STEER TIRE
15" x 4.62" solid pneumatic

OPERATOR COMPARTMENT

Ergonomic roomy cab, wide view mast, hydrostatic power steering with spinner knob, adjustable steering column and adjustable suspension seat ensures comfortable working position. Hydraulic controls: lift/lower, tilt, and load side-shift within easy reach of operator.

Large "wide view" reversing mirror increases operation efficiency. Side hand rail aids operator comfort in reverse driving position.

HYDRAULICS

Powerful AC hydraulic lift motor provides smooth high torque lifting and lowering. Hydraulic lift and drive components are sealed against dirt and water protecting them from contamination.

ELECTRICAL

AC technology fitted to heavy-duty applications. Electrical current is optimized and AC motors are brushless, which minimizes servicing. "neutral braking" eliminates truck roll-back and allow higher travel speeds. Diagnostic display with thirty performance travel and lift parameters can be adjusted to suit all types of loads, working condition's area and operator driving skill.

DRIVE UNIT AND BRAKES

Dual drive motors offer great maneuverability. The incorporation of ZF® developed components, including finely engineered helical gears, assured low noise, high quality and a long service life with low maintenance.

The "V" series three-wheel truck has three independent braking systems: regenerative "neutral braking", hydraulic wet disc braking, and toggle-type parking brake.

FRAME AND MAST

High stability chassis with long wheel-base, wide tires and low center of gravity. "See Thru" integral side-shift with load back rest (LBR). Wide view mast, low scuttle and high seating position gives the operator an excellent view, reducing load damage and accidents. Fully enclosed chassis weldment house the dual drive motors.

SERVICEABILITY

The state of-the-art controller can be easily accessed at waist height, reducing service time. Uncomplicated removable side battery compartment allows battery maintenance.

STANDARD EQUIPMENT

- Headlights and Brake Lights
- Yellow Flashing Light
- Solid Pneumatic Tires
- Dual Steer Tire
- Integral Side-Shift
- Ergonomic Operators Compartment



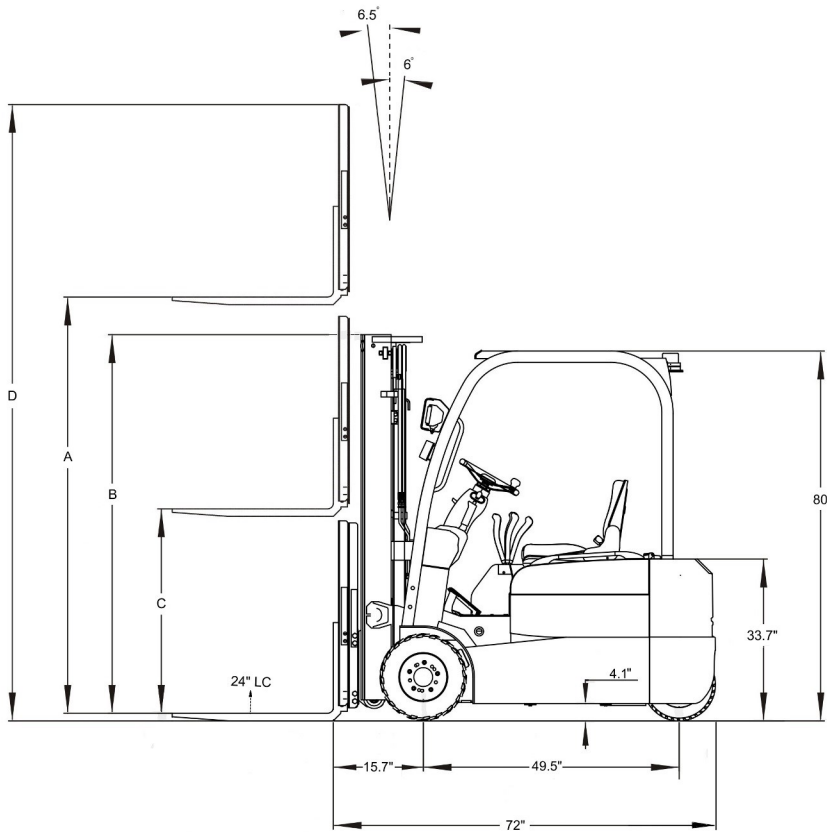

V-15 RATED CAPACITY

2800 lbs. to 118" @ 24" LC
 2000 lbs. to 189" @ 24" LC

Gradeability: Loaded 10.5%
 Unloaded 14.5%

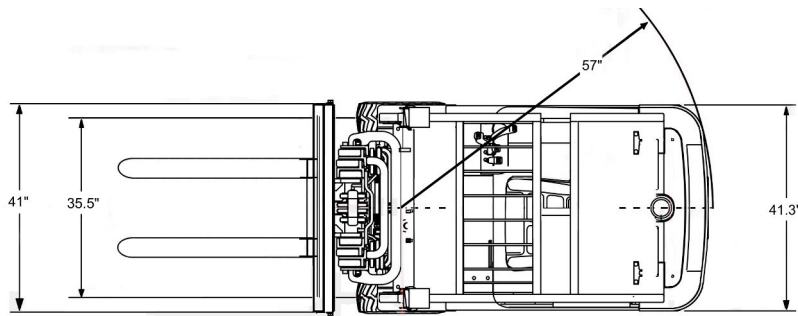

Model #	Mast	Lift Height	Col Height	Free Lift		Extended Height		³ Weight (lbs)
				Without Backrest	With Backrest	Without Backrest	With Backrest	
				C		D		

2800 lbs Capacity @ 24" Load Center

Model #	Mast	Lift Height	Col Height	Without Backrest	With Backrest	Without Backrest	With Backrest	³ Weight (lbs)
V15-177	TriMast	177	81	58	45	202	215	6698
V15-188	TriMast	189	85	62	48	214	226	6820

³Estimated shipping weight without battery